

# 2SC4468

Silicon NPN Triple Diffused Planar Transistor (Complement to type 2SA1695)

Application : Audio and General Purpose

■ Absolute maximum ratings (Ta=25°C)

Symbol	Ratings	Unit
V <sub>CB0</sub>	200	V
V <sub>CEO</sub>	140	V
V <sub>EB0</sub>	6	V
I <sub>C</sub>	10	A
I <sub>B</sub>	4	A
P <sub>C</sub>	100(T <sub>C</sub> =25°C)	W
T <sub>J</sub>	150	°C
T <sub>stg</sub>	-55 to +150	°C

■ Electrical Characteristics (Ta=25°C)

Symbol	Conditions	Ratings	Unit
I <sub>CB0</sub>	V <sub>CB</sub> =200V	10max	μA
I <sub>EB0</sub>	V <sub>EB</sub> =6V	10max	μA
V <sub>(BR)CEO</sub>	I <sub>C</sub> =50mA	140min	V
h <sub>FE</sub>	V <sub>CE</sub> =4V, I <sub>C</sub> =3A	50min*	
V <sub>CE(sat)</sub>	I <sub>C</sub> =5A, I <sub>B</sub> =0.5A	0.5max	V
f <sub>r</sub>	V <sub>CE</sub> =12V, I <sub>E</sub> =-0.5A	20typ	MHz
COB	V <sub>CB</sub> =10V, f=1MHz	250typ	pF

\*h<sub>FE</sub> Rank O(50to100), P(70to140), Y(90to180)

■ Typical Switching Characteristics (Common Emitter)

V <sub>CC</sub> (V)	R <sub>L</sub> (Ω)	I <sub>C</sub> (A)	V <sub>BB1</sub> (V)	V <sub>BB2</sub> (V)	I <sub>B1</sub> (A)	I <sub>B2</sub> (A)	t <sub>on</sub> (μs)	t <sub>stg</sub> (μs)	t <sub>f</sub> (μs)
60	12	5	10	-5	0.5	-0.5	0.24typ	4.32typ	0.40typ

External Dimensions MT-100(TO3P)

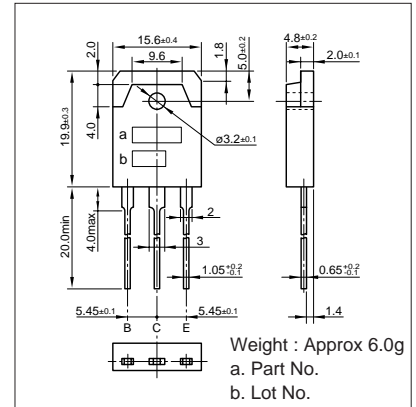

I<sub>C</sub>-V<sub>CE</sub> Characteristics (Typical)

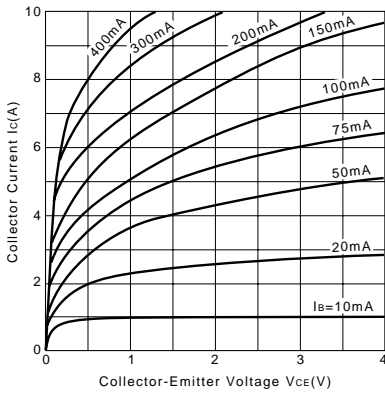

V<sub>CE(sat)</sub>-I<sub>B</sub> Characteristics (Typical)

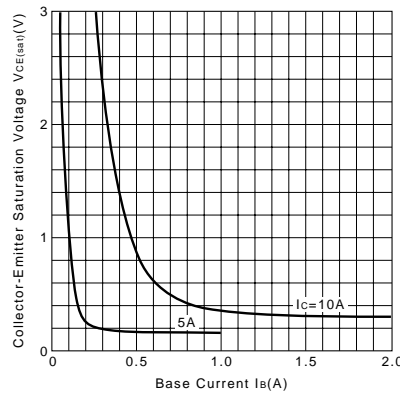

I<sub>C</sub>-V<sub>BE</sub> Temperature Characteristics (Typical)

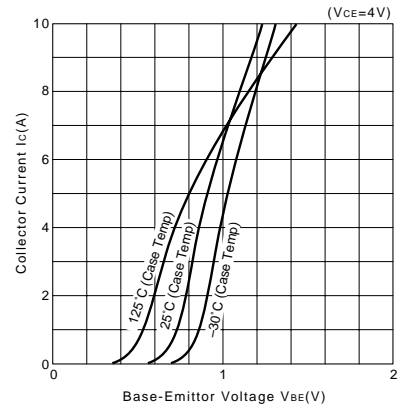

h<sub>FE</sub>-I<sub>C</sub> Characteristics (Typical)

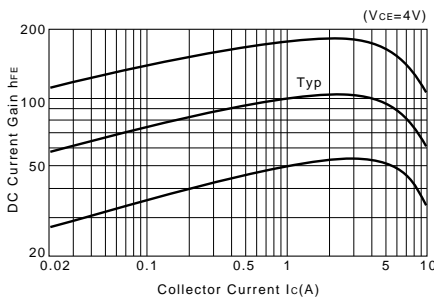

h<sub>FE</sub>-I<sub>C</sub> Temperature Characteristics (Typical)

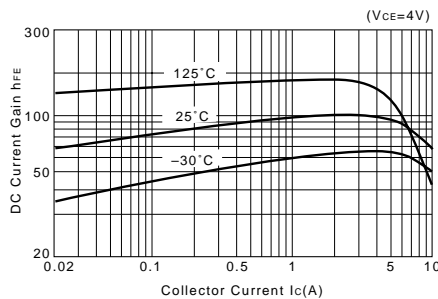

θ<sub>j-a</sub>-t Characteristics

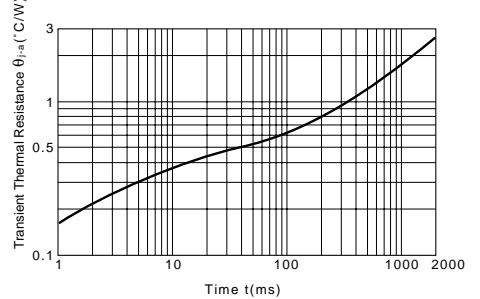

f<sub>T</sub>-I<sub>E</sub> Characteristics (Typical)

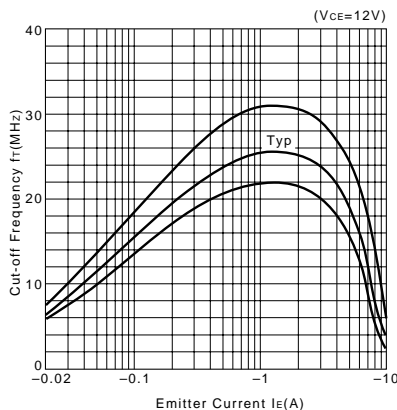

Safe Operating Area (Single Pulse)

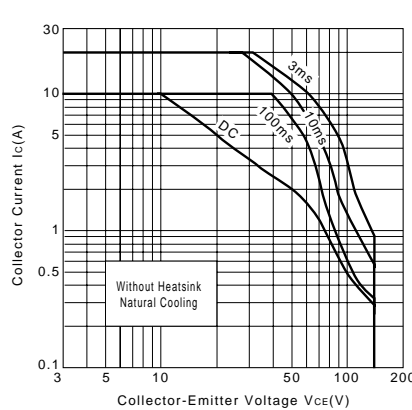

P<sub>C</sub>-T<sub>a</sub> Derating

