

Octal 3-State Noninverting Bus Transceiver

High-Performance Silicon-Gate CMOS

The SL74HC245 is identical in pinout to the LS/ALS245. The device inputs are compatible with standard CMOS outputs; with pullup resistors, they are compatible with LS/ALSTTL outputs.

The SL74HC245 is a 3-state noninverting transceiver that is used for 2-way asynchronous communication between data buses. The device has an active-low Output Enable pin, which is used to place the I/O ports into high-impedance states. The Direction control determines whether data flows from A to B or from B to A.

- Outputs Directly Interface to CMOS, NMOS, and TTL
- Operating Voltage Range: 2.0 to 6.0 V
- Low Input Current: 1.0 μ A
- High Noise Immunity Characteristic of CMOS Devices

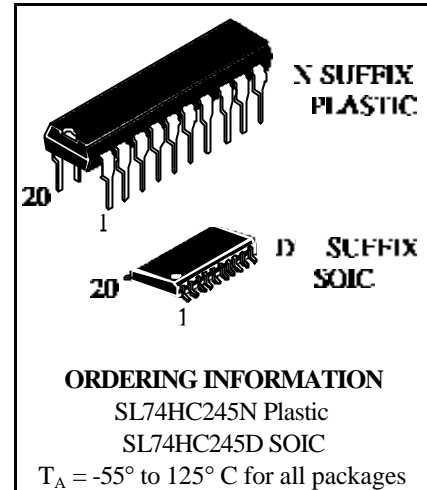

LOGIC DIAGRAM

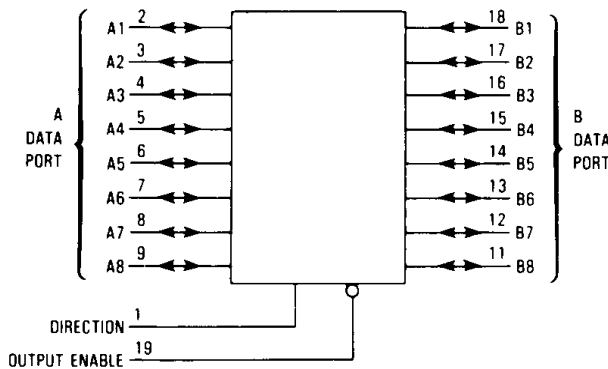

PIN ASSIGNMENT

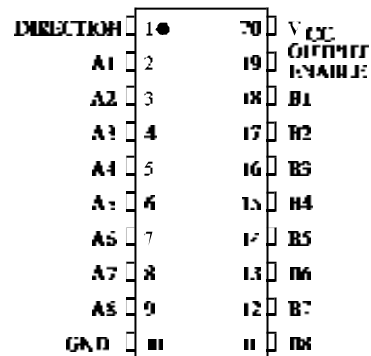

FUNCTION TABLE

Control Inputs		Operation
Output Enable	Direction	
L	L	Data Transmitted from Bus B to Bus A
L	H	Data Transmitted from Bus A to Bus B
H	X	Buses Isolated (High Impedance State)

X = don't care

SL74HC245

MAXIMUM RATINGS*

Symbol	Parameter	Value	Unit
V _{CC}	DC Supply Voltage (Referenced to GND)	-0.5 to +7.0	V
V _{IN}	DC Input Voltage (Referenced to GND)	-1.5 to V _{CC} +1.5	V
V _{OUT}	DC Output Voltage (Referenced to GND)	-0.5 to V _{CC} +0.5	V
I _{IN}	DC Input Current, per Pin	±20	mA
I _{OUT}	DC Output Current, per Pin	±35	mA
I _{CC}	DC Supply Current, V _{CC} and GND Pins	±75	mA
P _D	Power Dissipation in Still Air, Plastic DIP+ SOIC Package+	750 500	mW
T _{stg}	Storage Temperature	-65 to +150	°C
T _L	Lead Temperature, 1 mm from Case for 10 Seconds (Plastic DIP or SOIC Package)	260	°C

*Maximum Ratings are those values beyond which damage to the device may occur. Functional operation should be restricted to the Recommended Operating Conditions.
+Derating - Plastic DIP: - 10 mW/°C from 65° to 125°C
SOIC Package: - 7 mW/°C from 65° to 125°C

RECOMMENDED OPERATING CONDITIONS

Symbol	Parameter	Min	Max	Unit
V _{CC}	DC Supply Voltage (Referenced to GND)	2.0	6.0	V
V _{IN} , V _{OUT}	DC Input Voltage, Output Voltage (Referenced to GND)	0	V _{CC}	V
T _A	Operating Temperature, All Package Types	-55	+125	°C
t _r , t _f	Input Rise and Fall Time (Figure 1)			
	V _{CC} =2.0 V	0	1000	ns
	V _{CC} =4.5 V	0	500	
	V _{CC} =6.0 V	0	400	

This device contains protection circuitry to guard against damage due to high static voltages or electric fields. However, precautions must be taken to avoid applications of any voltage higher than maximum rated voltages to this high-impedance circuit. For proper operation, V_{IN} and V_{OUT} should be constrained to the range $GND \leq (V_{IN} \text{ or } V_{OUT}) \leq V_{CC}$.

Unused inputs must always be tied to an appropriate logic voltage level (e.g., either GND or V_{CC}). Unused outputs must be left open.

DC ELECTRICAL CHARACTERISTICS (Voltages Referenced to GND)

Symbol	Parameter	Test Conditions	V _{CC} V	Guaranteed Limit			Unit
				25 °C to -55°C	≤85 °C	≤125 °C	
V _{IH}	Minimum High-Level Input Voltage	V _{OUT} =0.1 V or V _{CC} -0.1 V I _{OUT} ≤ 20 μA	2.0	1.5	1.5	1.5	V
			4.5	3.15	3.15	3.15	
			6.0	4.2	4.2	4.2	
V _{IL}	Maximum Low-Level Input Voltage	V _{OUT} =0.1 V or V _{CC} -0.1 V I _{OUT} ≤ 20 μA	2.0	0.5	0.5	0.5	V
			4.5	1.35	1.35	1.35	
			6.0	1.8	1.8	1.8	
V _{OH}	Minimum High-Level Output Voltage	V _{IN} =V _{IH} or V _{IL} I _{OUT} ≤ 20 μA	2.0	1.9	1.9	1.9	V
			4.5	4.4	4.4	4.4	
		6.0	5.9	5.9	5.9		
		V _{IN} =V _{IH} or V _{IL} I _{OUT} ≤ 6.0 mA I _{OUT} ≤ 7.8 mA	4.5	3.98	3.84	3.7	
6.0	5.48	5.34	5.2				
V _{OL}	Maximum Low-Level Output Voltage	V _{IN} = V _{IL} or V _{IH} I _{OUT} ≤ 20 μA	2.0	0.1	0.1	0.1	V
			4.5	0.1	0.1	0.1	
		6.0	0.1	0.1	0.1		
		V _{IN} = V _{IL} or V _{IH} I _{OUT} ≤ 6.0 mA I _{OUT} ≤ 7.8 mA	4.5	0.26	0.33	0.4	
6.0	0.26	0.33	0.4				
I _{IN}	Maximum Input Leakage Current	V _{IN} =V _{CC} or GND, Pin 1 or 19	6.0	±0.1	±1.0	±1.0	μA
I _{OZ}	Maximum Three-State Leakage Current	Output in High-Impedance State V _{IN} = V _{IL} or V _{IH} V _{OUT} =V _{CC} or GND, I/O Pins	6.0	±0.5	±5.0	±10	μA
I _{CC}	Maximum Quiescent Supply Current (per Package)	V _{IN} =V _{CC} or GND I _{OUT} =0μA	6.0	4.0	40	160	μA

SL74HC245

AC ELECTRICAL CHARACTERISTICS ($C_L=50\text{pF}$, Input $t_r=t_f=6.0\text{ ns}$)

Symbol	Parameter	V _{CC} V	Guaranteed Limit			Unit
			25 °C to -55°C	≤85°C	≤125°C	
t _{PLH} , t _{PHL}	Maximum Propagation Delay, A to B or B to A (Figures 1 and 3)	2.0	75	95	110	ns
		4.5	15	19	22	
		6.0	13	16	19	
t _{PLZ} , t _{PHZ}	Maximum Propagation Delay, Direction or Output Enable to A or B (Figures 2 and 4)	2.0	110	140	165	ns
		4.5	22	28	33	
		6.0	19	24	28	
t _{PZL} , t _{PZH}	Maximum Propagation Delay, Direction or Output Enable to A or B (Figures 2 and 4)	2.0	110	140	165	ns
		4.5	22	28	33	
		6.0	19	24	28	
t _{TLH} , t _{THL}	Maximum Output Transition Time, Any Output (Figures 1 and 3)	2.0	60	75	90	ns
		4.5	12	15	18	
		6.0	10	13	15	
C _{IN}	Maximum Input Capacitance (Pin 1 or Pin 19)	-	10	10	10	pF
C _{OUT}	Maximum Three-State I/O Capacitance (I/O in High-Impedance State)	-	15	15	15	pF

C _{PD}	Power Dissipation Capacitance (Per Transceiver Channel)	Typical @25°C, V _{CC} =5.0 V			pF
	Used to determine the no-load dynamic power consumption: $P_D=C_{PD}V_{CC}^2f+I_{CC}V_{CC}$	40			

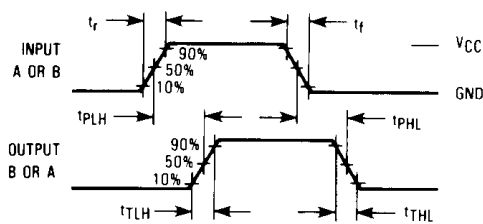

Figure 1. Switching Waveforms

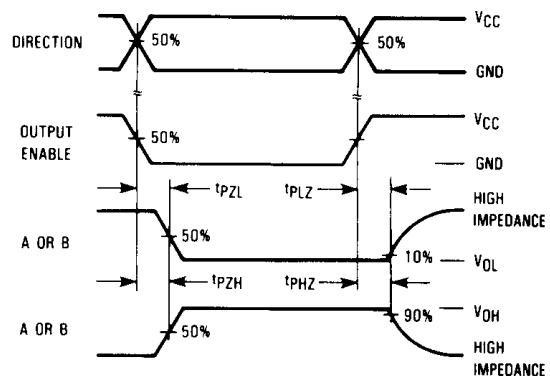
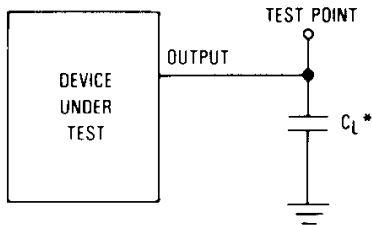
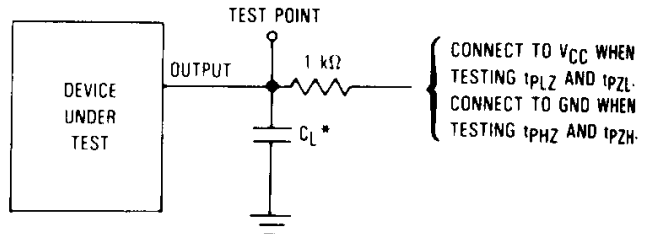

Figure 2. Switching Waveforms



*Includes all probe and jig capacitance.

Figure 3. Test Circuit



*Includes all probe and jig capacitance.

Figure 4. Test Circuit

EXPANDED LOGIC DIAGRAM

